

## HIGH PRESSURE HAND PUMP

1,500 bar/21,750 psi



## TWO STAGE, HIGH PRESSURE HAND PUMP

- Two-speed reduces handle strokes so you work faster and easier
- Built-in, protected pressure gauge
- Ergonomic design for minimal handle effort
- Lightweight aluminum reservoir
- Easily accessible refill port
- Needle valve allows full control when releasing tension

### DESIGNED FOR

Electric



Air



Gas



Hand



MAINTENANCE  
& REPAIR

ORIGINAL  
INSTALL

Split



Tension



Torque



Max  
Flow



## Specifications and Dimensional Data

**Size:** (L x W x H): 62 cm x 11 cm x 17 cm  
24.4" x 4.3" x 6.7"

**Weight:** 8.7 kg (19.1 lb) [with oil]

**Maximum Oil Capacity:** (vented reservoir)

1.1 L (0.29 Gallons) [to fill line]

1.0 L (0.26 Gallons) [usable]

**Operating Environment:** -25°C to +50°C  
(-13°F to +122°F)

(When operating near temperature extremes, it is recommended to use hydraulic oils that are rated for those temperatures. Refer to service manuals and cooling options)

**Pressure:** 0 - 1,500 bar (0 - 21,750 psi)

**Typical Flow:** 20 cm<sup>3</sup> stroke - 1 cm<sup>3</sup> stroke  
(1.22 in<sup>3</sup>/stroke - 0.061 in<sup>3</sup>/stroke)

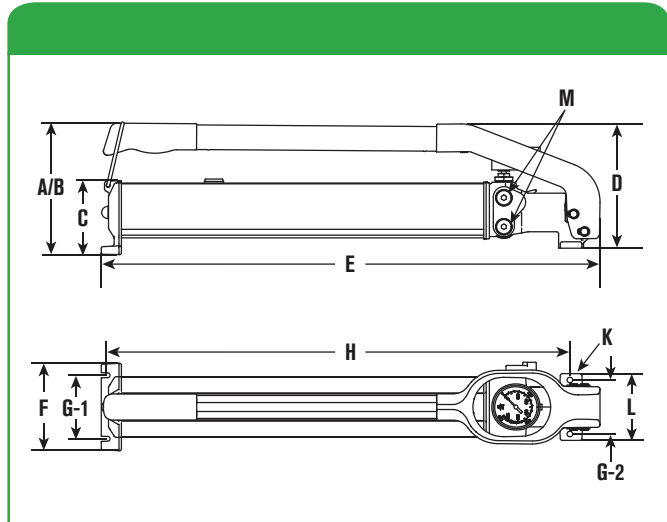



Order No.	A mm in	B mm in	C mm in	D mm in	E mm in	F mm in	G1 mm in	G2 mm in	H mm in	J deg	K mm in	L mm in	M in
HPUHP150001	170	560	152	170	620	110	80	68	575	55	6.6	84	61/4"
	6.69	22	6	6.69	24.41	4.33	3.15	2.68	22.64	55	0.26	3.31	61/4"

## Ordering Information

For use with	Order No	Speed	Volume per Stroke		Maximum Pressure		Handle Effort	Oil Capacity	Usable Oil Capacity	Oil Port	Product Weight
			LP in <sup>3</sup> cm <sup>3</sup>	HP in <sup>3</sup> cm <sup>3</sup>	LP psi bar	HP psi bar					
Tensioners	HPUHP150001	2	1.22	0.061	290	21750	83	61	61	61/4"	19.1
			20	1	20	1,500	370	1	1	61/4"	8.7

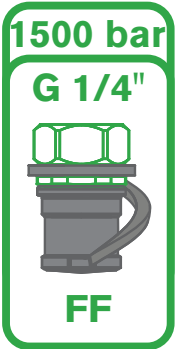
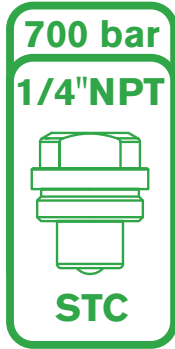
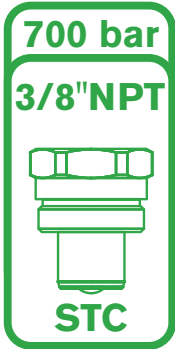
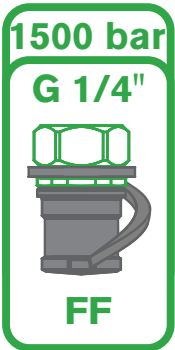
## Coupler Explanation

		1,500 BAR 21750 PSI	700 BAR 10000 PSI	
		TENSIONERS	TORQUE WRENCHES ENS SPLITTER	OTHER TOOLS
TOPSIDE		 <p>1500 bar G 1/4" FF</p>	 <p>700 bar 1/4"NPT STC</p>	 <p>700 bar 3/8"NPT STC</p>
		 <p>1500 bar G 1/4" FF</p>	 <p>700 bar 1/4"NPT FF</p>	

Male FF couplers can connect to recessed style (standard) couplers and Flat Face (optional) couplers. Contact factory for information about Flat Face coupler options.

### Coupler Icon Explanation

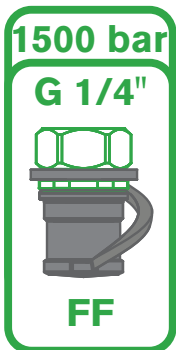

**RATED PRESSURE**

700 bar (10,000 psi) or 1,500 bar (21,750 psi)

**THREAD TYPE**

1/4" NPT or 3/8" NPT or G 1/4"

**ICON**

**COUPLER TYPE**

STC = Screw to Connect or FF = Flat Face

### No Coupler Included

Some products do not include couplers. Couplers need to be ordered separately.

